

Model	Size [mm]	A [mm]
KTSXx47P + KTS_X00X	700x2000	675-700
KTSXx42P + KTS_X00X	800x2000	775-800
KTSXx41P + KTS_X00X	900x2000	875-900
KTSXx43P + KTS_X00X	1000x2000	975-1000

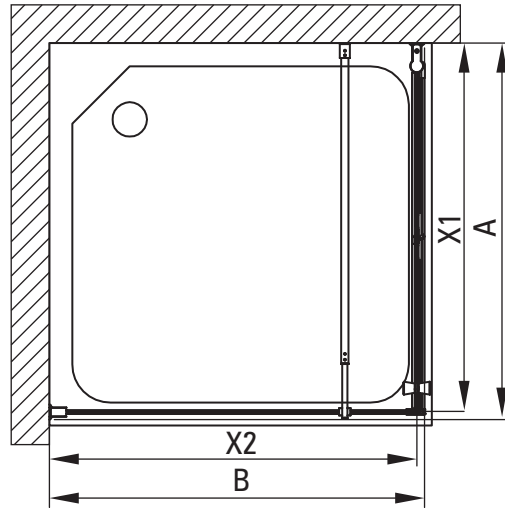

Model	Size [mm]	A [mm]	X1 [mm]
KTSXx47P	700x2000	685-700	665-680
KTSXx42P	800x2000	785-800	765-780
KTSXx41P	900x2000	885-900	865-880
KTSXx43P	1000x2000	985-1000	965-980

Model	B [mm]	X2 [mm]
KTS_X83P	285-300	265-280
KTS_X84P	385-400	365-380
KTS_X85P	485-500	465-480
KTS_X86P	585-600	565-580
KTS_X37P	685-700	665-680
KTS_X38P	785-800	765-780
KTS_X39P	885-900	865-880
KTS_X30P	985-1000	965-980
KTS_X31P	1085-1100	1065-1080
KTS_X32P	1185-1200	1165-1180
KTS_X34P	1385-1400	1365-1380

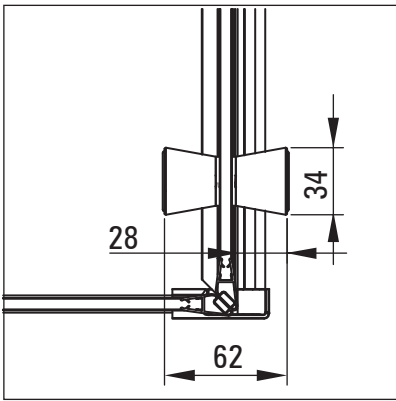
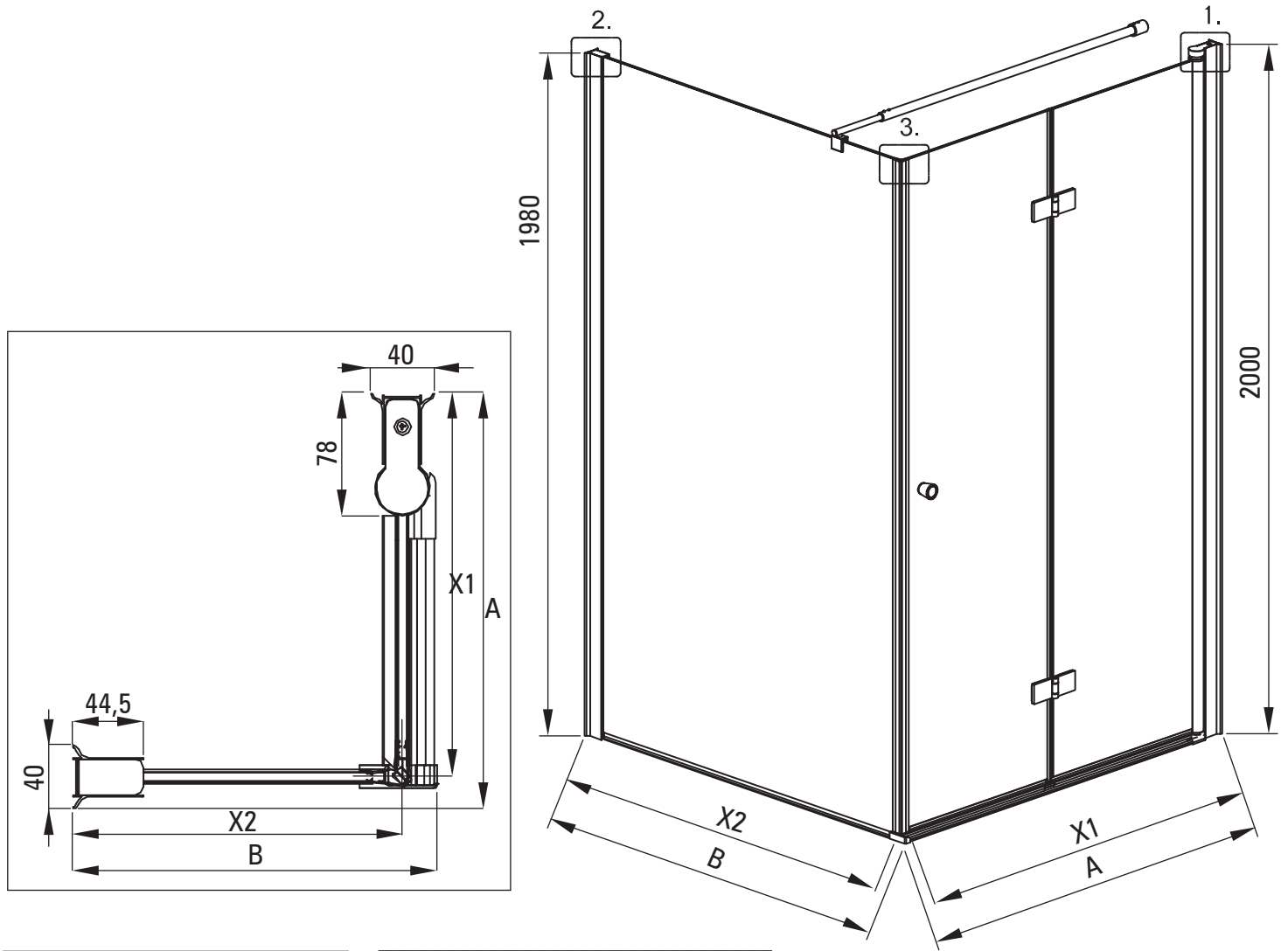
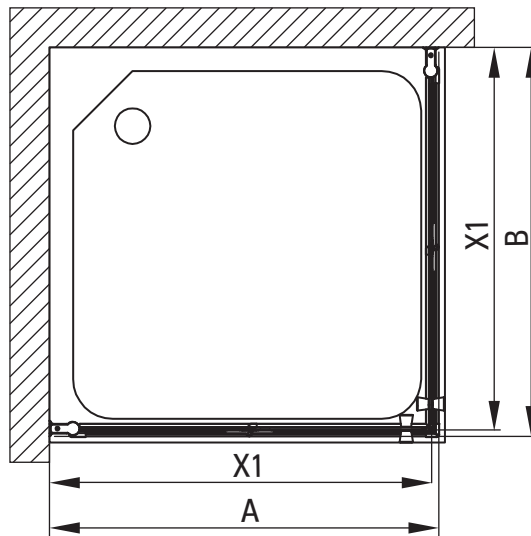
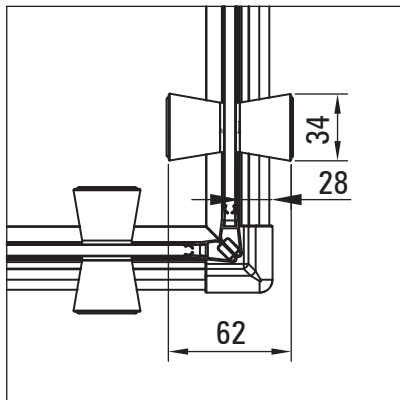
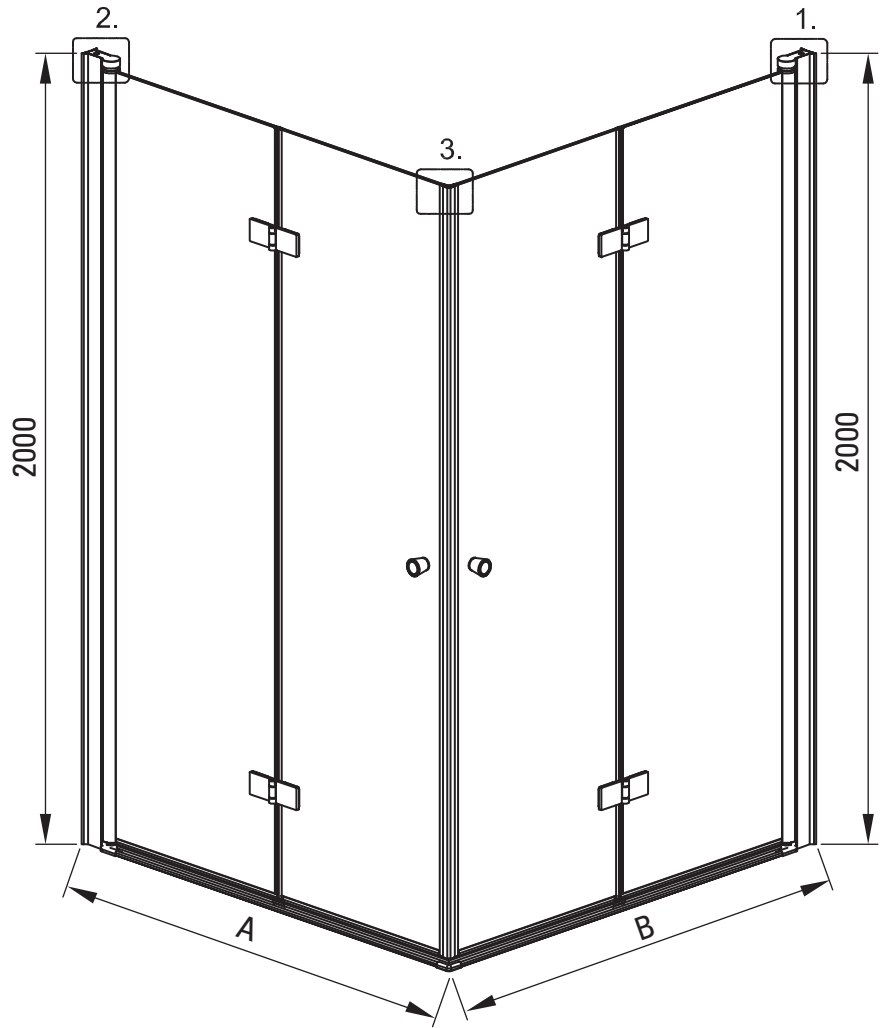
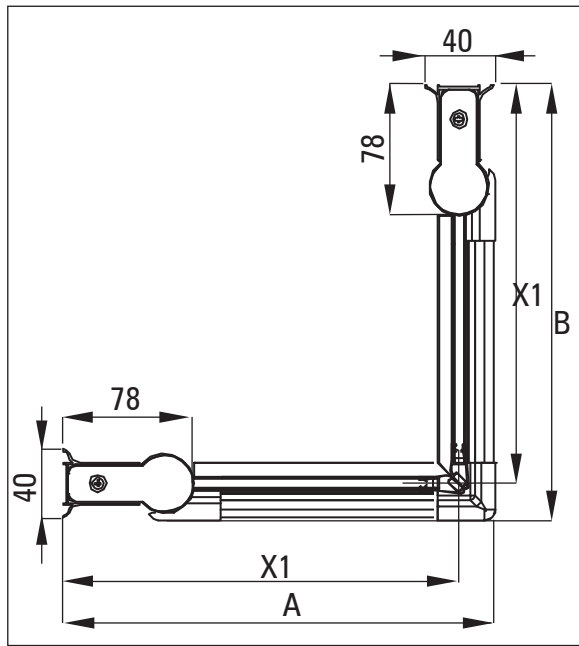

Model	Size [mm]	A [mm]	B [mm]	X1 [mm]
KTSXx47P	700x2000	685-700	685-700	665-680
KTSXx42P	800x2000	785-800	785-800	765-780
KTSXx41P	900x2000	885-900	885-900	865-880
KTSXx43P	1000x2000	985-1000	985-1000	965-980

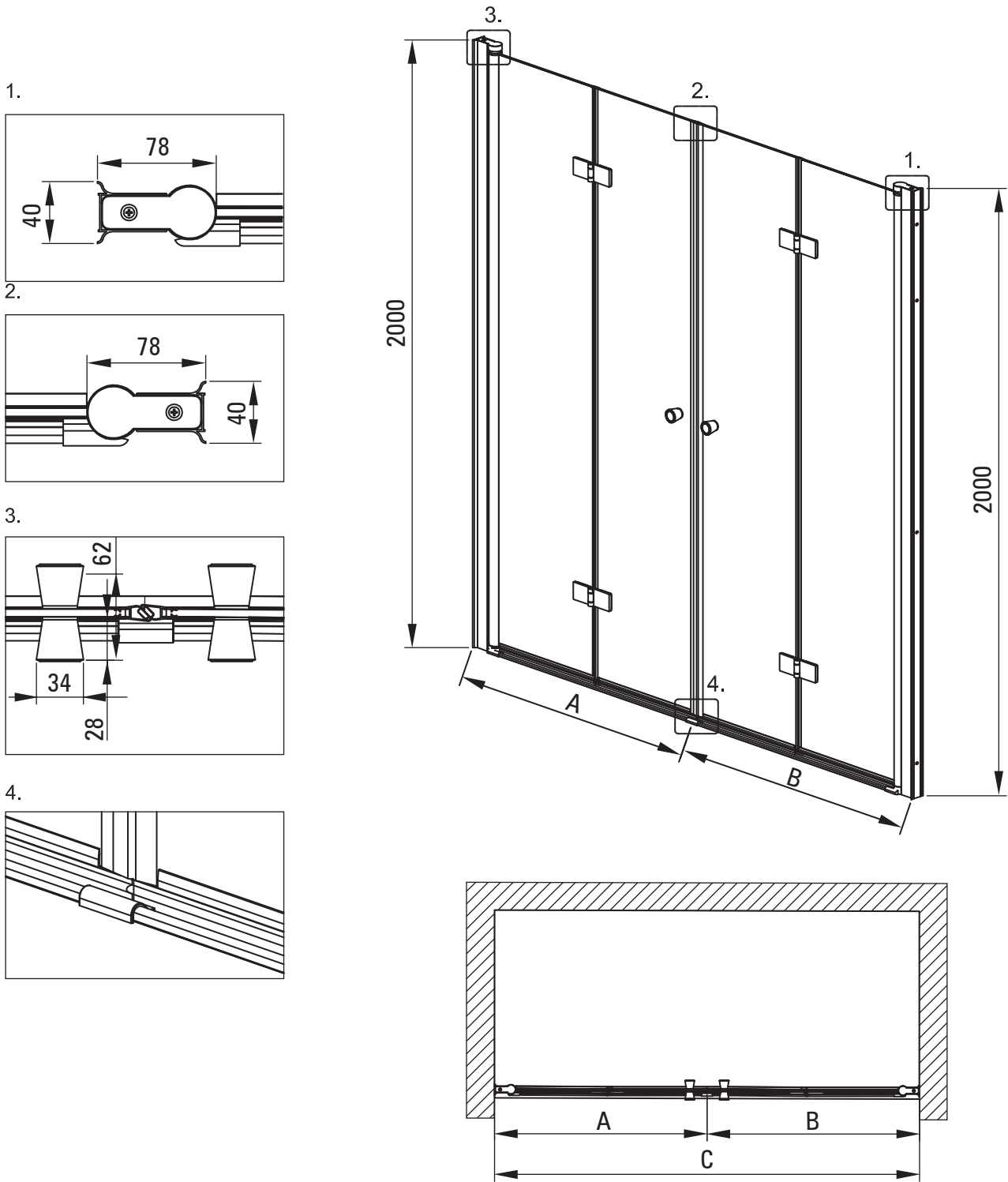

Model	Size [mm]	A [mm]	B [mm]
KTSXx47P	(A+B)x2000	670-690	670-690
KTSXx42P	(A+B)x2000	770-790	770-790
KTSXx41P	(A+B)x2000	870-890	870-890
KTSXx43P	(A+B)x2000	970-990	970-990

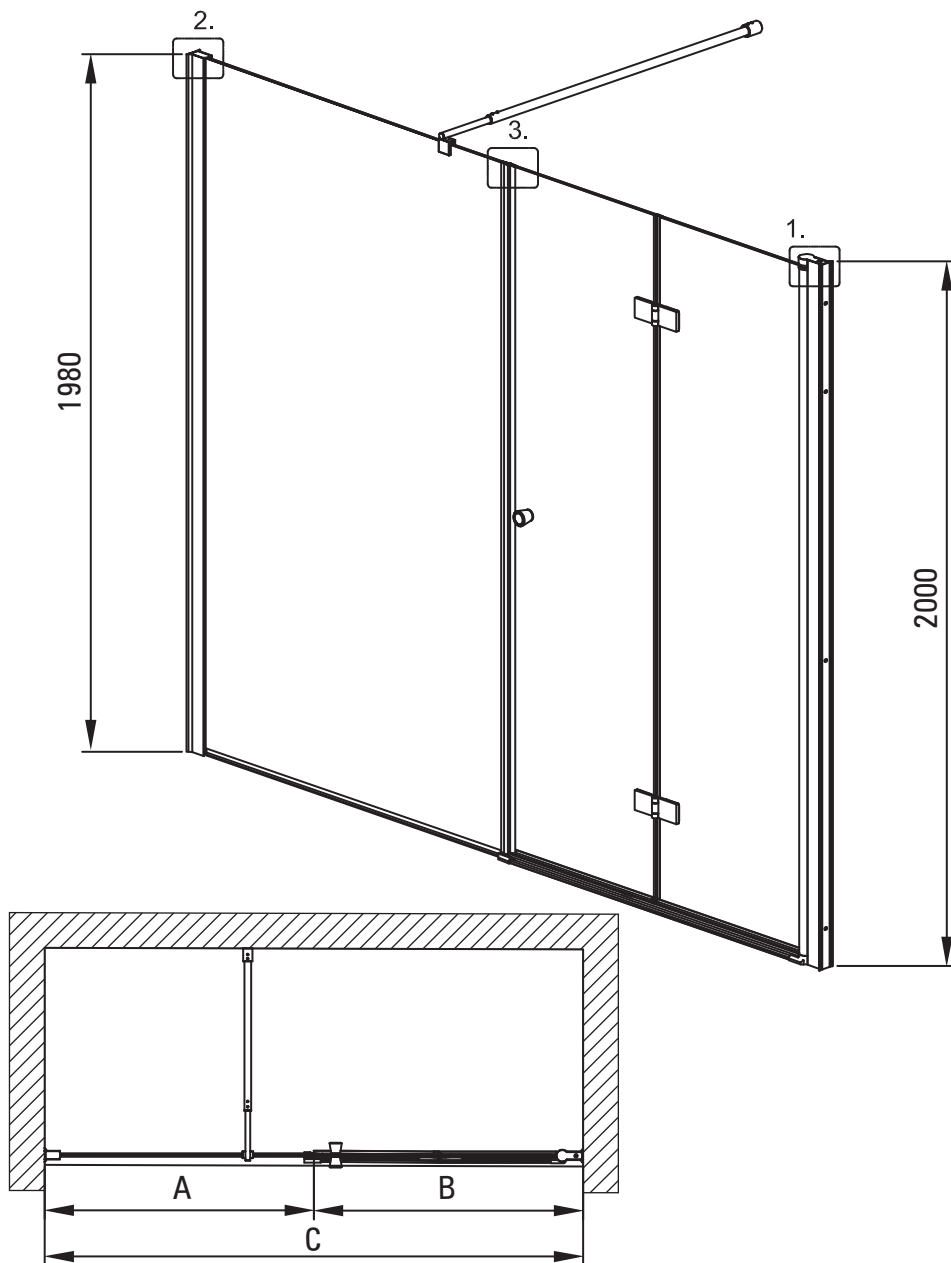
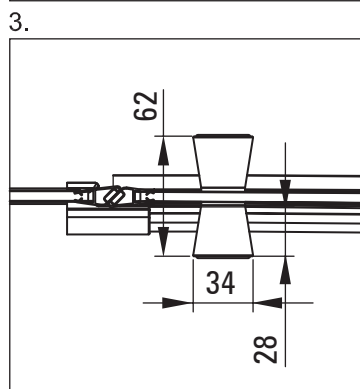
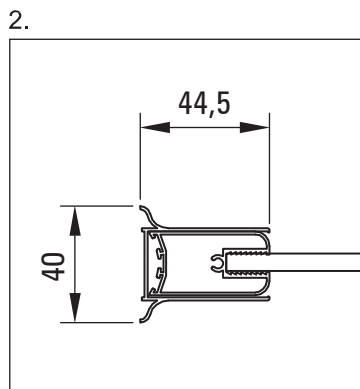
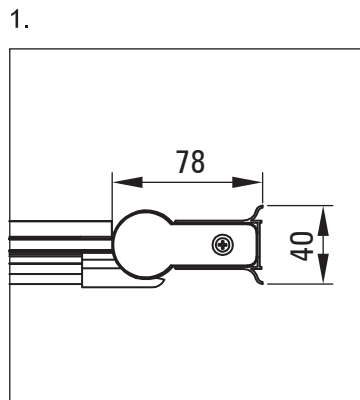

A [mm] + B [mm] = C [mm]		Model Size			
Model	Size	KTSXx47P B= 670-690	KTSXx42P B= 770-790	KTSXx41P B= 870-890	KTSXx43P B= 970-990
KTS_X83P	A= 260-280	C= 930-970	C= 1030-1070	C= 1130-1170	C= 1230-1270
KTS_X84P	A= 360-380	C= 1030-1070	C= 1130-1170	C= 1230-1270	C= 1330-1370
KTS_X85P	A= 460-480	C= 1130-1170	C= 1230-1270	C= 1330-1370	C= 1430-1470
KTS_X86P	A= 560-580	C= 1230-1270	C= 1330-1370	C= 1430-1470	C= 1530-1570
KTS_X37P	A= 660-680	C= 1330-1370	C= 1430-1470	C= 1530-1570	C= 1630-1670
KTS_X38P	A= 760-780	C= 1430-1470	C= 1530-1570	C= 1630-1670	C= 1730-1770
KTS_X39P	A= 860-880	C= 1530-1570	C= 1630-1670	C= 1730-1770	C= 1830-1870
KTS_X30P	A= 960-980	C= 1630-1670	C= 1730-1770	C= 1830-1870	C= 1930-1970
KTS_X31P	A= 1060-1080	C= 1730-1770	C= 1830-1870	C= 1930-1970	C= 2030-2070
KTS_X32P	A= 1160-1180	C= 1830-1870	C= 1930-1970	C= 2030-2070	C= 2130-2170
KTS_X34P	A= 1360-1380	C= 2030-2070	C= 2130-2170	C= 2230-2270	C= 2330-2370